

Bearing No. FWF-141817

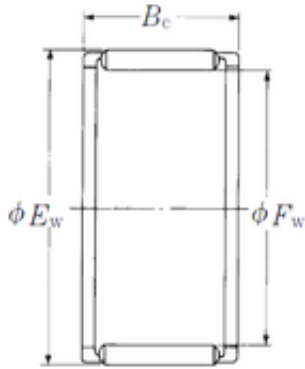

Fw	14 mm
Ew	18 mm
Bc	17 mm
Weight	0,0069 Kg
Bearing number	FWF-141817
Bore Diameter (mm)	14
Outer Diameter (mm)	18
Basic dynamic load rating (C)	10,7 kN
Basic static load rating (C0)	14,1 kN