

Bearing No. FWF-152013

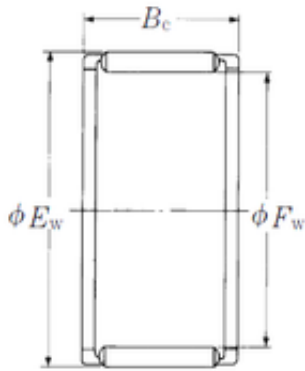

Fw	15 mm
Ew	20 mm
Bc	13 mm
Weight	0,0072 Kg
Bearing number	FWF-152013
Bore Diameter (mm)	15
Outer Diameter (mm)	20
Basic dynamic load rating (C)	9,95 kN
Basic static load rating (C0)	11,3 kN