

Bearing No. FWF-162117

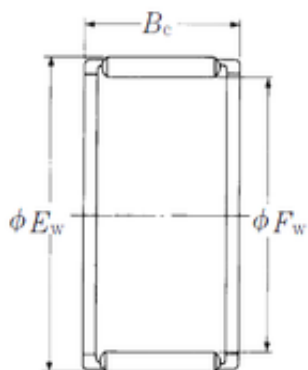

Fw	16 mm
Ew	21 mm
Bc	17 mm
Weight	0,01 Kg
Bearing number	FWF-162117
Bore Diameter (mm)	16
Outer Diameter (mm)	21
Basic dynamic load rating (C)	13 kN
Basic static load rating (C0)	16,2 kN