

### Bearing No. FWF-162127

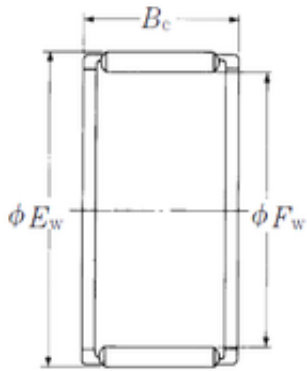

Fw	16 mm
Ew	21 mm
Bc	27 mm
Weight	0,016 Kg
Bearing number	FWF-162127
Bore Diameter (mm)	16
Outer Diameter (mm)	21
Basic dynamic load rating (C)	20,8 kN
Basic static load rating (C0)	29,6 kN