

Bearing No. FWF-162420

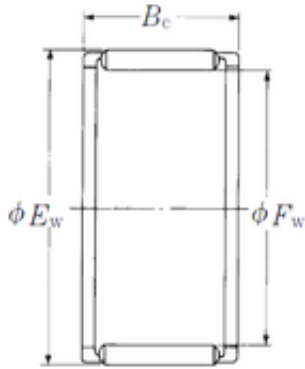

Fw	16 mm
Ew	24 mm
Bc	20 mm
Weight	0,02 Kg
Bearing number	FWF-162420
Bore Diameter (mm)	16
Outer Diameter (mm)	24
Basic dynamic load rating (C)	20,8 kN
Basic static load rating (C0)	22,2 kN