

### Bearing No. FWF-172115

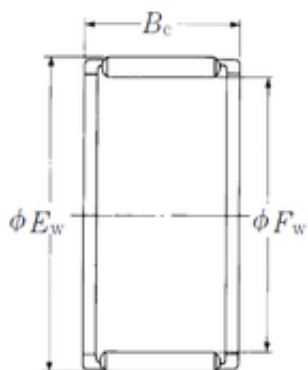

Fw	17 mm
Ew	21 mm
Bc	15 mm
Weight	0,0075 Kg
Bearing number	FWF-172115
Bore Diameter (mm)	17
Outer Diameter (mm)	21
Basic dynamic load rating (C)	10,8 kN
Basic static load rating (C0)	15 kN