

Bearing No. FWF-182217

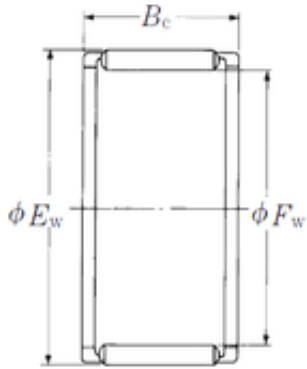

Fw	18 mm
Ew	22 mm
Bc	17 mm
Weight	0,0087 Kg
Bearing number	FWF-182217
Bore Diameter (mm)	18
Outer Diameter (mm)	22
Basic dynamic load rating (C)	12,6 kN
Basic static load rating (C0)	18,6 kN