

Bearing No. 53312

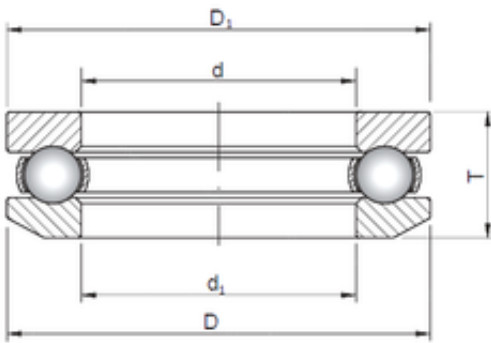

d	60 mm
D	110 mm
T	38,3 mm
d1	62 mm
D1	110 mm
Weight	1,47 Kg
Bearing number	53312
Bore Diameter (mm)	60
Outer Diameter (mm)	110
(Grease) Lubrication Speed	1500 r/min
Basic dynamic load rating (C)	124 kN
Basic static load rating (C0)	267 kN