

### Bearing No. FWF-182320

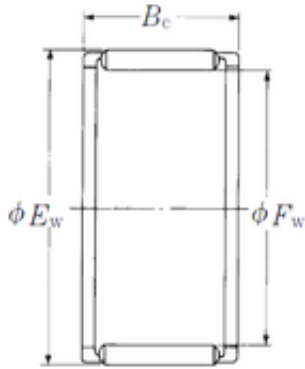

Fw	18 mm
Ew	23 mm
Bc	20 mm
Weight	0,013 Kg
Bearing number	FWF-182320
Bore Diameter (mm)	18
Outer Diameter (mm)	23
Basic dynamic load rating (C)	16,6 kN
Basic static load rating (C0)	22,9 kN