

Bearing No. FWF-182517

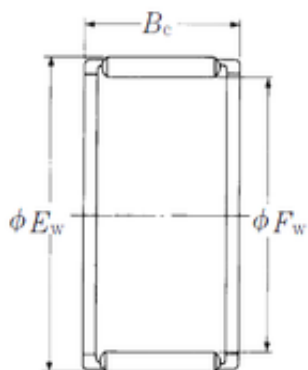

Fw	18 mm
Ew	25 mm
Bc	17 mm
Weight	0,019 Kg
Bearing number	FWF-182517
Bore Diameter (mm)	18
Outer Diameter (mm)	25
Basic dynamic load rating (C)	16,5 kN
Basic static load rating (C0)	18,3 kN