

Bearing No. FWF-182522

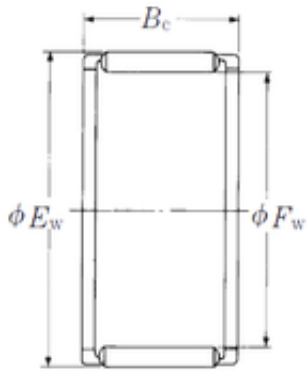

Fw	18 mm
Ew	25 mm
Bc	22 mm
Weight	0,021 Kg
Bearing number	FWF-182522
Bore Diameter (mm)	18
Outer Diameter (mm)	25
Basic dynamic load rating (C)	21,3 kN
Basic static load rating (C0)	25,5 kN