

Bearing No. FWF-202417

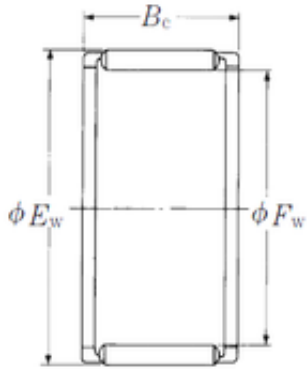

Fw	20 mm
Ew	24 mm
Bc	17 mm
Weight	0,0095 Kg
Bearing number	FWF-202417
Bore Diameter (mm)	20
Outer Diameter (mm)	24
Basic dynamic load rating (C)	12,4 kN
Basic static load rating (C0)	18,8 kN