

Bearing No. FWF-202616

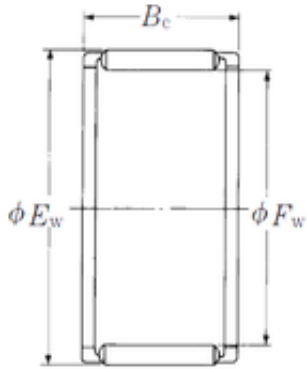

Fw	20 mm
Ew	26 mm
Bc	16 mm
Weight	0,014 Kg
Bearing number	FWF-202616
Bore Diameter (mm)	20
Outer Diameter (mm)	26
Basic dynamic load rating (C)	16,6 kN
Basic static load rating (C0)	21 kN