

Bearing No. FWF-202820

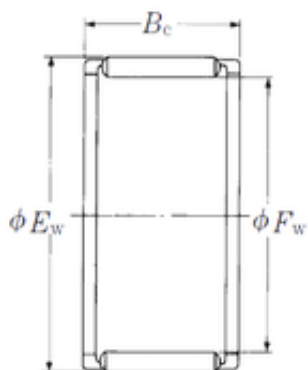

Fw	20 mm
Ew	28 mm
Bc	20 mm
Weight	0,028 Kg
Bearing number	FWF-202820
Bore Diameter (mm)	20
Outer Diameter (mm)	28
Basic dynamic load rating (C)	19,8 kN
Basic static load rating (C0)	21,7 kN