

Bearing No. FWF-212517

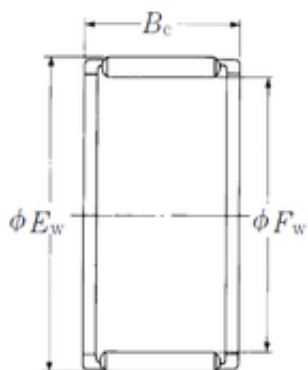

Fw	21 mm
Ew	25 mm
Bc	17 mm
Weight	0,01 Kg
Bearing number	FWF-212517
Bore Diameter (mm)	21
Outer Diameter (mm)	25
Basic dynamic load rating (C)	13,1 kN
Basic static load rating (C0)	20,6 kN