

Bearing No. FWF-222617

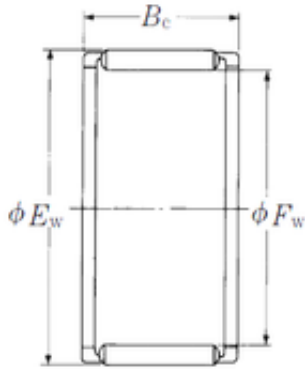

Fw	22 mm
Ew	26 mm
Bc	17 mm
Weight	0,01 Kg
Bearing number	FWF-222617
Bore Diameter (mm)	22
Outer Diameter (mm)	26
Basic dynamic load rating (C)	13 kN
Basic static load rating (C0)	20,7 kN