

Bearing No. FWF-222720

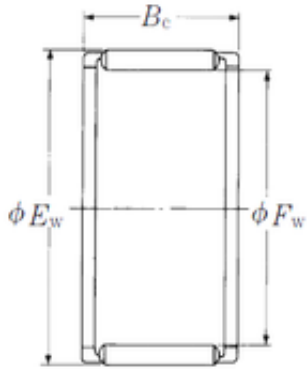

Fw	22 mm
Ew	27 mm
Bc	20 mm
Weight	0,016 Kg
Bearing number	FWF-222720
Bore Diameter (mm)	22
Outer Diameter (mm)	27
Basic dynamic load rating (C)	18 kN
Basic static load rating (C0)	27 kN