

Bearing No. FWF-242817

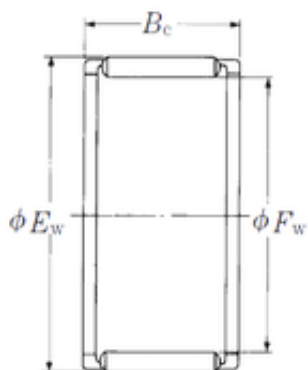

Fw	24 mm
Ew	28 mm
Bc	17 mm
Weight	0,011 Kg
Bearing number	FWF-242817
Bore Diameter (mm)	24
Outer Diameter (mm)	28
Basic dynamic load rating (C)	14,6 kN
Basic static load rating (C0)	24,7 kN