

Bearing No. FWF-243017

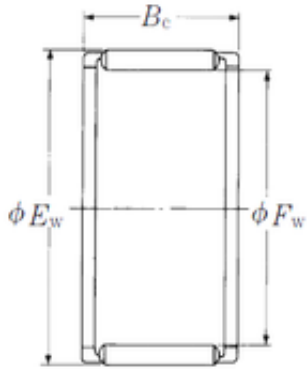

Fw	24 mm
Ew	30 mm
Bc	17 mm
Weight	0,014 Kg
Bearing number	FWF-243017
Bore Diameter (mm)	24
Outer Diameter (mm)	30
Basic dynamic load rating (C)	17,9 kN
Basic static load rating (C0)	24,3 kN