

Bearing No. FWF-253013

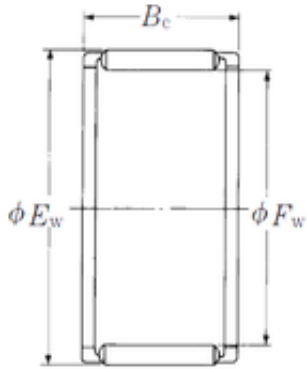

Fw	25 mm
Ew	30 mm
Bc	13 mm
Weight	0,011 Kg
Bearing number	FWF-253013
Bore Diameter (mm)	25
Outer Diameter (mm)	30
Basic dynamic load rating (C)	13,5 kN
Basic static load rating (C0)	19,5 kN