

Bearing No. FWF-253017

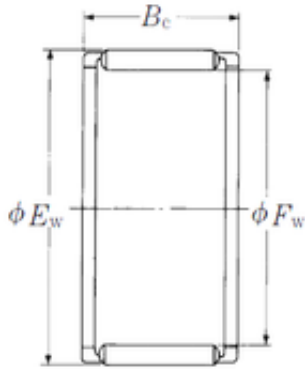

Fw	25 mm
Ew	30 mm
Bc	17 mm
Weight	0,014 Kg
Bearing number	FWF-253017
Bore Diameter (mm)	25
Outer Diameter (mm)	30
Basic dynamic load rating (C)	17,2 kN
Basic static load rating (C0)	26,4 kN