

Bearing No. FWF-253120

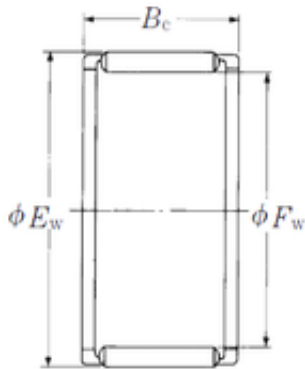

Fw	25 mm
Ew	31 mm
Bc	20 mm
Weight	0,021 Kg
Bearing number	FWF-253120
Bore Diameter (mm)	25
Outer Diameter (mm)	31
Basic dynamic load rating (C)	22,1 kN
Basic static load rating (C0)	32 kN