

### Bearing No. FWF-263017

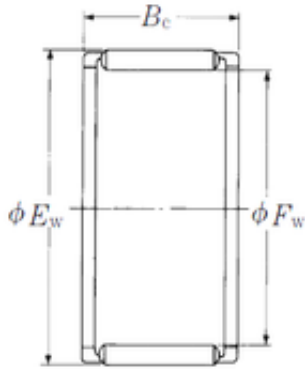

Fw	26 mm
Ew	30 mm
Bc	17 mm
Weight	0,012 Kg
Bearing number	FWF-263017
Bore Diameter (mm)	26
Outer Diameter (mm)	30
Basic dynamic load rating (C)	14,4 kN
Basic static load rating (C0)	24,9 kN