

Bearing No. FWF-283326

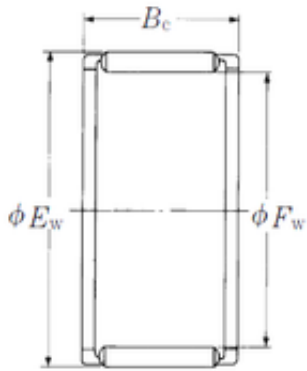

Fw	28 mm
Ew	33 mm
Bc	26 mm
Weight	0,025 Kg
Bearing number	FWF-283326
Bore Diameter (mm)	28
Outer Diameter (mm)	33
Basic dynamic load rating (C)	27,1 kN
Basic static load rating (C0)	49 kN