

**Bearing No. FWF-283327**

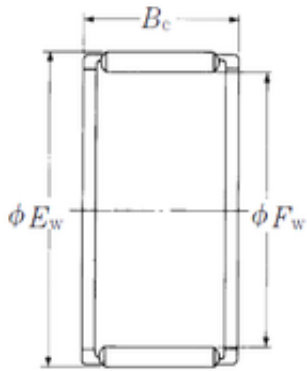

Fw	28 mm
Ew	33 mm
Bc	27 mm
Weight	0,026 Kg
Bearing number	FWF-283327
Bore Diameter (mm)	28
Outer Diameter (mm)	33
Basic dynamic load rating (C)	28,1 kN
Basic static load rating (C0)	51,5 kN