

### Bearing No. FWF-293417

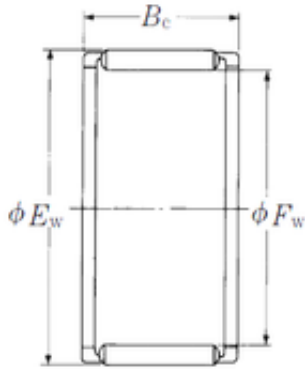

Fw	29 mm
Ew	34 mm
Bc	17 mm
Weight	0,017 Kg
Bearing number	FWF-293417
Bore Diameter (mm)	29
Outer Diameter (mm)	34
Basic dynamic load rating (C)	17,5 kN
Basic static load rating (C0)	28,4 kN