

Bearing No. FWF-303520

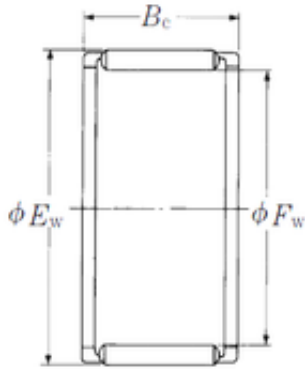

Fw	30 mm
Ew	35 mm
Bc	20 mm
Weight	0,021 Kg
Bearing number	FWF-303520
Bore Diameter (mm)	30
Outer Diameter (mm)	35
Basic dynamic load rating (C)	21 kN
Basic static load rating (C0)	36 kN