

Bearing No. FWF-303527

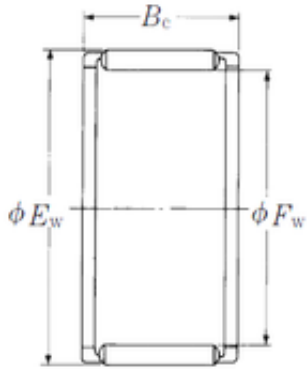

Fw	30 mm
Ew	35 mm
Bc	27 mm
Weight	0,028 Kg
Bearing number	FWF-303527
Bore Diameter (mm)	30
Outer Diameter (mm)	35
Basic dynamic load rating (C)	28,7 kN
Basic static load rating (C0)	54 kN