

Bearing No. FWF-303620

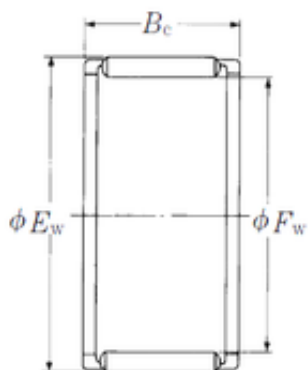

Fw	30 mm
Ew	36 mm
Bc	20 mm
Weight	0,025 Kg
Bearing number	FWF-303620
Bore Diameter (mm)	30
Outer Diameter (mm)	36
Basic dynamic load rating (C)	24,3 kN
Basic static load rating (C0)	38,5 kN