

### Bearing No. FWF-303818

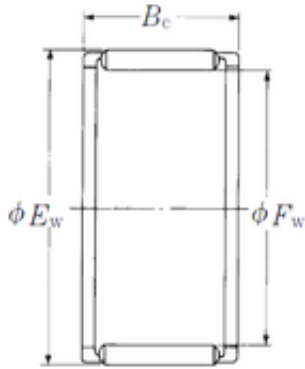

Fw	30 mm
Ew	38 mm
Bc	18 mm
Weight	0,032 Kg
Bearing number	FWF-303818
Bore Diameter (mm)	30
Outer Diameter (mm)	38
Basic dynamic load rating (C)	25,5 kN
Basic static load rating (C0)	34 kN