

Bearing No. FWF-303820

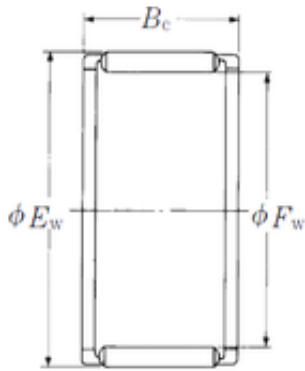

Fw	30 mm
Ew	38 mm
Bc	20 mm
Weight	0,035 Kg
Bearing number	FWF-303820
Bore Diameter (mm)	30
Outer Diameter (mm)	38
Basic dynamic load rating (C)	25,9 kN
Basic static load rating (C0)	34,5 kN