

Bearing No. FWF-303827

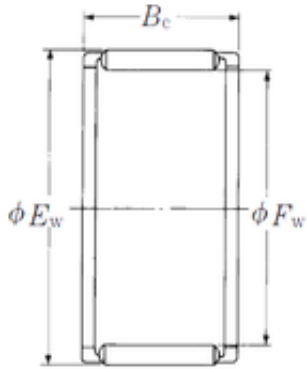

Fw	30 mm
Ew	38 mm
Bc	27 mm
Weight	0,047 Kg
Bearing number	FWF-303827
Bore Diameter (mm)	30
Outer Diameter (mm)	38
Basic dynamic load rating (C)	38,5 kN
Basic static load rating (C0)	57,5 kN