

### Bearing No. FWF-324020

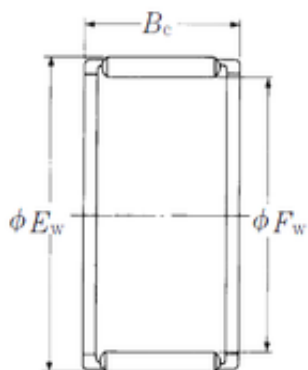

Fw	32 mm
Ew	40 mm
Bc	20 mm
Weight	0,037 Kg
Bearing number	FWF-324020
Bore Diameter (mm)	32
Outer Diameter (mm)	40
Basic dynamic load rating (C)	28,4 kN
Basic static load rating (C0)	39,5 kN