

### Bearing No. FWF-354027

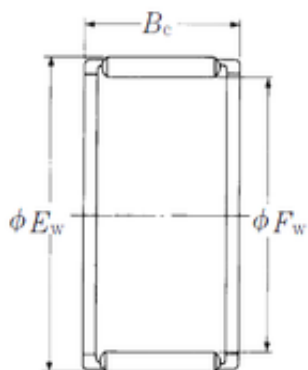

Fw	35 mm
Ew	40 mm
Bc	27 mm
Weight	0,032 Kg
Bearing number	FWF-354027
Bore Diameter (mm)	35
Outer Diameter (mm)	40
Basic dynamic load rating (C)	31,5 kN
Basic static load rating (C0)	64 kN