

Bearing No. FWF-354218

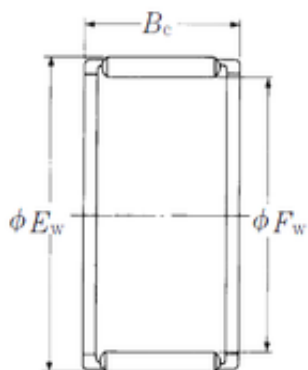

Fw	35 mm
Ew	42 mm
Bc	18 mm
Weight	0,031 Kg
Bearing number	FWF-354218
Bore Diameter (mm)	35
Outer Diameter (mm)	42
Basic dynamic load rating (C)	25,9 kN
Basic static load rating (C0)	39,5 kN