

Bearing No. FWF-364825

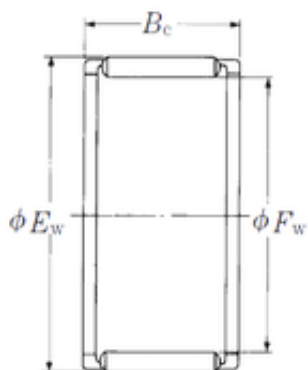

Fw	36 mm
Ew	48 mm
Bc	25 mm
Weight	0,08 Kg
Bearing number	FWF-364825
Bore Diameter (mm)	36
Outer Diameter (mm)	48
Basic dynamic load rating (C)	48,5 kN
Basic static load rating (C0)	62,5 kN