

Bearing No. FWF-374218

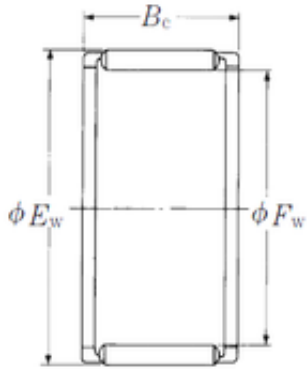

Fw	37 mm
Ew	42 mm
Bc	13 mm
Weight	0,016 Kg
Bearing number	FWF-374218
Bore Diameter (mm)	37
Outer Diameter (mm)	42
Basic dynamic load rating (C)	16,5 kN
Basic static load rating (C0)	28,4 kN