

Bearing No. FWF-374230

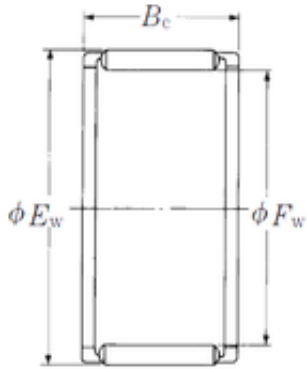

Fw	37 mm
Ew	42 mm
Bc	30 mm
Weight	0,043 Kg
Bearing number	FWF-374230
Bore Diameter (mm)	37
Outer Diameter (mm)	42
Basic dynamic load rating (C)	35,5 kN
Basic static load rating (C0)	77 kN