

Bearing No. FWF-384313

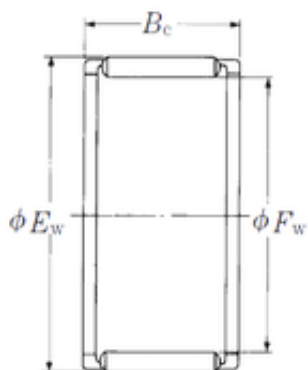

Fw	38 mm
Ew	43 mm
Bc	13 mm
Weight	0,017 Kg
Bearing number	FWF-384313
Bore Diameter (mm)	38
Outer Diameter (mm)	43
Basic dynamic load rating (C)	16,4 kN
Basic static load rating (C0)	28,5 kN