

**Bearing No. FWF-384327**

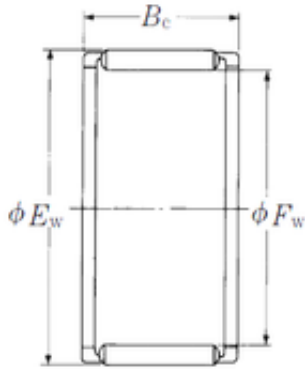

Fw	38 mm
Ew	43 mm
Bc	27 mm
Weight	0,035 Kg
Bearing number	FWF-384327
Bore Diameter (mm)	38
Outer Diameter (mm)	43
Basic dynamic load rating (C)	32,5 kN
Basic static load rating (C0)	68,5 kN