

Bearing No. FWF-404513

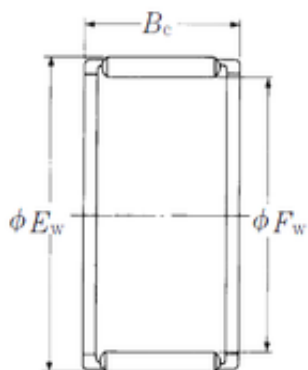

Fw	40 mm
Ew	45 mm
Bc	13 mm
Weight	0,018 Kg
Bearing number	FWF-404513
Bore Diameter (mm)	40
Outer Diameter (mm)	45
Basic dynamic load rating (C)	15,7 kN
Basic static load rating (C0)	27,5 kN