

Bearing No. FWF-475217

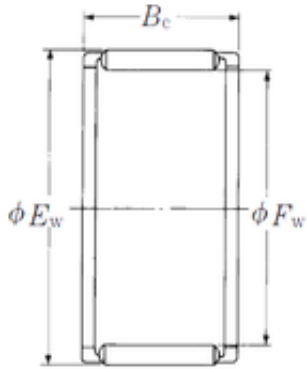

Fw	47 mm
Ew	52 mm
Bc	17 mm
Weight	0,027 Kg
Bearing number	FWF-475217
Bore Diameter (mm)	47
Outer Diameter (mm)	52
Basic dynamic load rating (C)	23,4 kN
Basic static load rating (C0)	48,5 kN