

Bearing No. FWF-475227

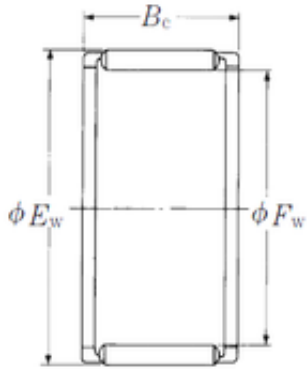

Fw	47 mm
Ew	52 mm
Bc	27 mm
Weight	0,043 Kg
Bearing number	FWF-475227
Bore Diameter (mm)	47
Outer Diameter (mm)	52
Basic dynamic load rating (C)	34,5 kN
Basic static load rating (C0)	79,5 kN