

Bearing No. FWF-485420

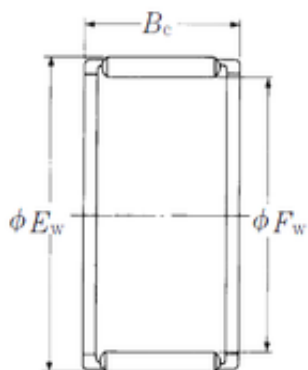

Fw	48 mm
Ew	54 mm
Bc	20 mm
Weight	0,039 Kg
Bearing number	FWF-485420
Bore Diameter (mm)	48
Outer Diameter (mm)	54
Basic dynamic load rating (C)	29,8 kN
Basic static load rating (C0)	58,5 kN