

Bearing No. FWF-556020

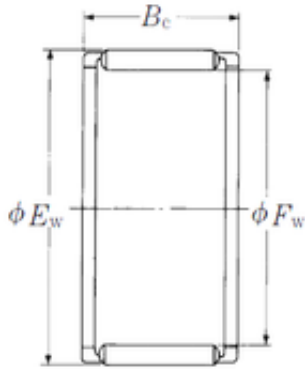

Fw	55 mm
Ew	60 mm
Bc	20 mm
Weight	0,041 Kg
Bearing number	FWF-556020
Bore Diameter (mm)	55
Outer Diameter (mm)	60
Basic dynamic load rating (C)	27,5 kN
Basic static load rating (C0)	62,5 kN