

Bearing No. FWF-556027

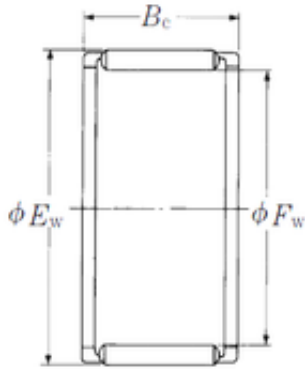

Fw	55 mm
Ew	60 mm
Bc	27 mm
Weight	0,055 Kg
Bearing number	FWF-556027
Bore Diameter (mm)	55
Outer Diameter (mm)	60
Basic dynamic load rating (C)	36 kN
Basic static load rating (C0)	89 kN