

Bearing No. FWF-556030

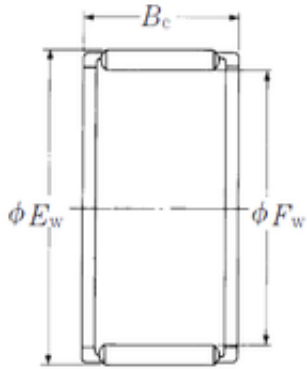

Fw	55 mm
Ew	60 mm
Bc	30 mm
Weight	0,061 Kg
Bearing number	FWF-556030
Bore Diameter (mm)	55
Outer Diameter (mm)	60
Basic dynamic load rating (C)	41 kN
Basic static load rating (C0)	105 kN