

Bearing No. FWF-606723

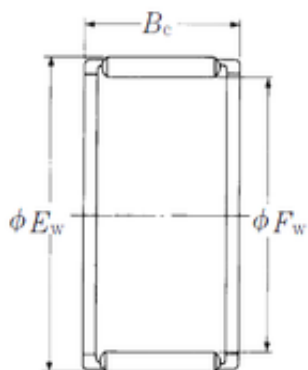

Fw	60 mm
Ew	67 mm
Bc	23 mm
Weight	0,073 Kg
Bearing number	FWF-606723
Bore Diameter (mm)	60
Outer Diameter (mm)	67
Basic dynamic load rating (C)	41,5 kN
Basic static load rating (C0)	86,5 kN