

Bearing No. FWF-606823

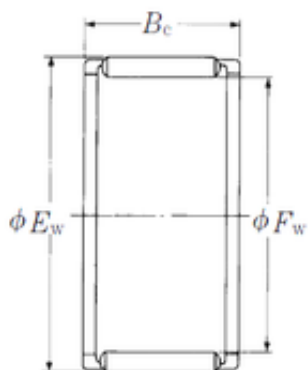

Fw	60 mm
Ew	68 mm
Bc	23 mm
Weight	0,084 Kg
Bearing number	FWF-606823
Bore Diameter (mm)	60
Outer Diameter (mm)	68
Basic dynamic load rating (C)	47,5 kN
Basic static load rating (C0)	94 kN