

### Bearing No. FWF-606827

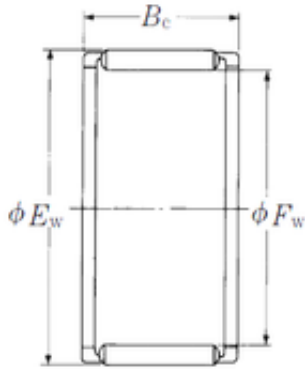

Fw	60 mm
Ew	68 mm
Bc	27 mm
Weight	0,098 Kg
Bearing number	FWF-606827
Bore Diameter (mm)	60
Outer Diameter (mm)	68
Basic dynamic load rating (C)	51,5 kN
Basic static load rating (C0)	103 kN